

M8 female 0° with cable, shielded

PVC 3x0.34 shielded bk UL/CSA 15m

Female straight

M8, 3-pole

shielded

with cable sleeves

Further cable lengths on request.

Plastic housings with good resistance against chemicals and oils.

The resistance to aggressive media should be individually tested for your application. Further details on request.

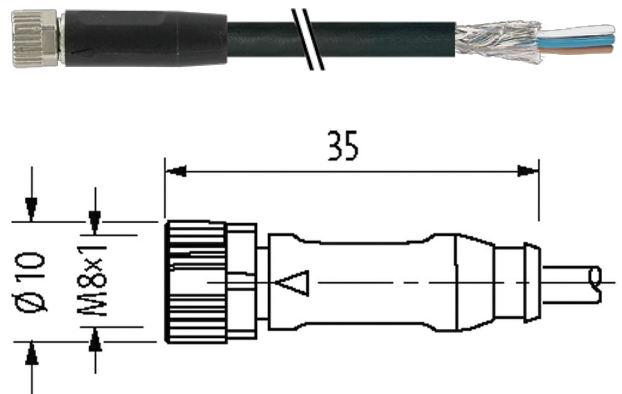
Illustration

Product may differ from Image

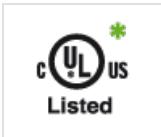
Approvals

* only for products with UL/CSA approved cable

cCSAus

Form

Form 08741

General data

Standards DIN EN 61076-2-104 (M8)

Temperature range -25...+85 °C, depending on cable quality

Cables

No./diameter of wires	3 × 0.34 mm ²
Wire isolation	PVC (br, bl, bk)
Material (jacket)	PVC (UL/CSA)
Outer Ø	5.0 mm ±5%
Temperature range (fixed)	-30...+80 °C
Temperature range (mobile)	-5...+80 °C
Cable identification	600
Cable Type	1 (PVC)
Approval (cable)	UL (AWM-Style 2464/1731), CSA
Cable weight [g/m]	52,80
Material (wire)	Cu wire, bare
Resistor (core)	max. 57 Ω/km (20 °C)

Single wire Ø (core)	0.15 mm
Construction (core)	19× 0.15 mm (multi-strand wire class 5)
Diameter (core)	3× 0.34 mm ²
AWG	similar to AWG 22
Material (wire isolation)	PVC
Material property (wire isolation)	CFC-, cadmium-, silicone- and lead-free, matt, low-adhesion, machine easy to process, abrasion-resistant
Shore hardness (wire isolation)	45 ±5 D
Wire-Ø incl. isolation	1.25 mm ±5%
Color/numbering of wires	br, bk, bl
Stranding combination	3 wires twisted
Shield	yes
	min. 80%
Material (jacket)	PVC
Material property (jacket)	CFC-, cadmium-, silicone- and lead-free, matt, low-adhesion, machine easy to process, abrasion-resistant
Shore hardness (jacket)	85 ±5 A
Outer-Ø (jacket)	5.0 mm ±5%
Color (jacket)	black
chemical resistance	good resistance to oil, gasoline and chemicals
thermal resistance	flame retardant UL 1581 VW1 / CSA FT1
Nominal voltage	300 V AC
Test voltage	2000 V AC
Current load capacity	to DIN VDE 0298-4
Temperature range (fixed)	-30...+80 °C
Temperature range (mobile)	-5...+80 °C
Bend radius (fixed)	10× outer Ø
Jacket Color	black

Technical Data

Operating voltage	max. 50 V AC/60 V DC
Rated surge voltage	1.5 kV
Operating current per contact	max. 4 A
Locking of ports	Screw thread (M8×1 mm) recommended torque 0.4 Nm, self-securing
Compression gland	M8 (SW9)
Protection	IP65, IP66K, IP67 inserted and tightened (EN 60529)

Commercial data

country of origin	DE
customs tariff number	85444290
EAN	4048879575874
eClass	27279218
Packaging unit	1

Sketch

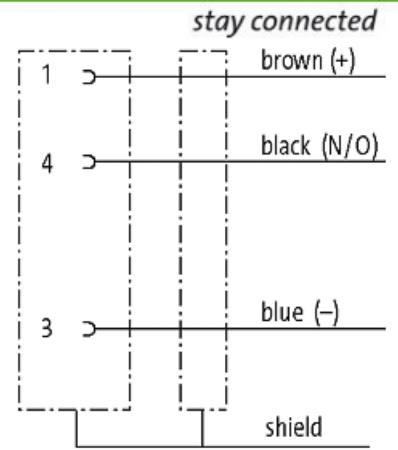

Female

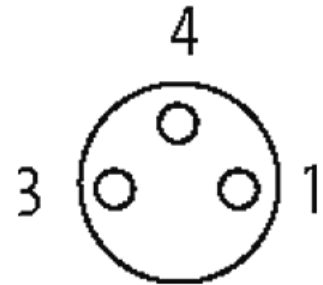

Product may differ from Image